

OPERATION MANUAL

PEN TYPE WATER QUALITY METER



- Model:** ■ 8352, Conductivity pen
■ 8362, Cond.&TDS pen
■ 8372, Salinity pen
■ 8373, Salinity & TDS pen

INTRODUCTION

Congratulations on your purchase of this pen type meter. Please read the manual completely before using this meter. Filing and keeping the manual for future reference. Recommended to soak the electrode for at least 30 min. before using to clear up the lazy effect.

Features:

- **IP65 Waterproof** housing.
- **Wide** measuring range and **multiple** units to fulfill all kinds of applications.
- **Dual display** with ATC
- **Data hold** to freeze readings.
- **Pen size**, easy to fit into pocket.
- **Low battery** indicator.
- **Auto power off**.
- **C/F** unit switchable.
- Powered by 4pcs **LR44** batteries.
- **Multi points** calibration.
- **One touch** only for calibration.

MATERIAL SUPPLIED

This package contains:

- ✓ The meter x 1
- ✓ LR44 button battery x 4
- ✓ Operation manual
- ✓ Color box or plain box

POWER SUPPLY

The meter is powered by 4 pcs LR44 batteries. To check the battery when:

1. First time use
2. The battery symbol appears on LCD
3. The meter can not power on

To install the batteries:

1. Turn off the meter.
2. Loosen the battery cover in counter-clockwise direction. (DON'T discard the black washer!)
3. Replace the old batteries with four new button cells LR44.
4. Make sure the batteries are in place and the polarity is correct.
5. Put back the battery cover and turn it tightly in clockwise direction.

NOTE:

- 1. Remove battery from instruments that you do not plan to use for a month or more. Do not leave battery in instrument.**

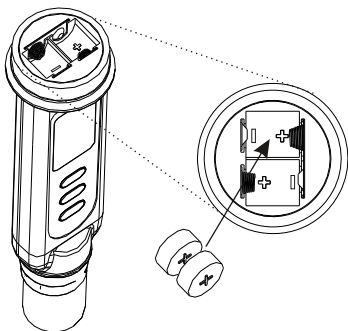

LCD DISPLAY



- The 1st display shows the measured reading.
- The 2nd display shows the reading of temp.
- uS or mS is the unit of Conductivity
- ppt or ppm is the unit of TDS
- ppm, ppt, S.G. or % is the unit of salinity
- C or F is the unit of liquid temperature
-  is the battery low icon

KEYPAD

8352



SET



HOLD/CAL



8362/8372/8373



SET



HOLD/CAL



MODE

OPERATION

1. Press "  " to power on the meter. Full LCD will be displayed for some seconds and then enter normal display.

2. The meter is designed as auto-ranging since powered on. Auto-ranging determines and selects a range which gives you the greatest resolution and accuracy. There is no manual-ranging function in this water quality pen.
3. Rinse the probe with deionized or distilled water before use to remove any impurities adhering to the electrode. If the meter is not used for a long time, please soak the probe more than 30 minutes to clear up the lazy effect of probe.
4. Dip the probe into the sample till the temperature sensor point is also immersed into water. Make sure there are no air bubbles trapped on the probe. To remove air bubbles, insert the probe into liquid and then swing in air to get rid of water. Repeat this procedure many times till you can't see air bubble attached on probe.



5. Stir the probe gently in the sample to create a homogenous sample. Allow a few seconds to reach temp. equilibrium. (Wait about 15 minutes can get a stable reading)

6. Press "▼
HOLD/CAL" to freeze current readings. The text "H" will appear on the LCD. Press "▼
HOLD/CAL" again to release.

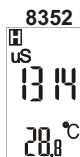

7. TDS Measurement:

8362/8373

In **8362 & 8373**, press "▲
MODE" to switch to TDS mode. The units for TDS are ppm or ppt and "TDS" icon will appear



Note:

Be sure to set the TDS conversion factor in right value to bring you correct result. The factory default is 0.50

To change the TDS factors, refer to page 8 setting mode.

8. Salinity Measurement:

8372/8373 is designed for salinity measurement with 3 different display unit: ppm(or ppt), % and specific gravity. In model **8372**: press "▲
MODE" to switch to different salinity unit in model **8373**:press "▲
MODE" to switch between different salinity unit and to TDS mode.

9. Turn off the meter by pressing "⓪
SET".

10. Electrode Maintenance :

- a) Make sure your electrode is clean!
- b) Store the electrode carefully!
Before storage, rinse it carefully in deionised water and store **dry** and store the meter under 0~50°C.



11. Accuracy & Air bubbles:

The air bubbles are easy to adhere around the electrode and will affect the accuracy a lot. By swing wet probe in air can get rid of bubble easily, just need to repeat this procedure about 5 times: **Dip in water -> Swing to get rid of bubble -> Dip in water -> Swing to get rid of bubble....**

AUTO POWER OFF (SLEEP FUNCTION)

This meter will shut off automatically 20 minutes of inactivity. For operating longer time, you can disable the sleep mode.

To disable the auto power off:

Before power on, pressing "  " + "  " keys simultaneously until a "n" appeared on the screen and then release keys to return to normal mode.



NOTE:

The disable sleep mode will be invalid after every power off.

SETUP

The advanced setup mode lets you customized your meter's preferences and defaults.

To change the parameters, you can press "  " more than 2 sec. to enter setup mode when the meter is in measurement mode.

P3.0: Review Calibration Info.: (CAL)

Press key to select **P3.0**. There are three calibration ranges so you can find P3.3 to P3.5 here. This section is for you to **"review" the calibration information. Not for you to calibrate the pen.**

P3.3: Range 1 calibration info.:

In P3.0, press "  " momentarily to enter P3.3 and you can see the last calibration concentration.



P3.4: Range 2 calibration info.:

In P3.3, press "  " to enter P3.4 and you can see the last calibration concentration.

P3.5: Range 3 calibration info.:

In P3.4, press "  " to enter P3.5 and you can see the last calibration concentration.



Press "  " momentarily to return to P3.0.

 uS 1413 P3.3	 mS 1200 P3.4	 mS 1110 P3.5
---	---	---

In these 3 calibration range, the previous calibration data will be replaced after re-calibration. Ex: if you previously calibrated at 1413 uS (range1), when re-calibrate it at 450 uS, the previous 1413uS will become 450uS. However, the meter will retain the calibration data for other ranges unchanged

P4.0 Cond. Cell Constant (Review)

P4.0 is used to review the current cell constant at different 3 ranges. This value should be between 0.8 to 1.2. This is an indicator to remind you if it is necessary to purchase a new pen.





1. Press key to select **P4.0**. There are three ranges so you can find P4.3 to P4.5 here. Pressing "  " to enter P4.3
2. Using "  " to switch to P4.4 and P4.5 to review cell constant of each range. Press "  " again to return to CEL P4.0 screen.



P5.0: TDS factor setting: (tdS,8362/8373)

Press key to select **P5.0** in setting mode



P5.1: Setting TDS factor(tdF):



In P5.0, press "  " momentarily to enter. The factor will flash on LCD. Press "  " or "  " to change factor from 0.30 to 1.00. Press "  " momentarily to confirm the value and meter will return to P5.0



P7.0: temperature unit setting: (unt)

P7.1: Change temperature unit (tUt):

When meter is in measurement mode, press "  " more than 2 sec to enter setup mode. Press key to select **P7.0**, then press "  " momentarily again to enter unit setting.

Press "  " or "  " to select C /F. Press "  " momentarily to confirm the unit and return to P7.0

While in P7.0, press "  " for more than 2 seconds to return to measurement mode.

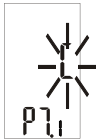

To be summarized, the operation procedure of setting up function is:

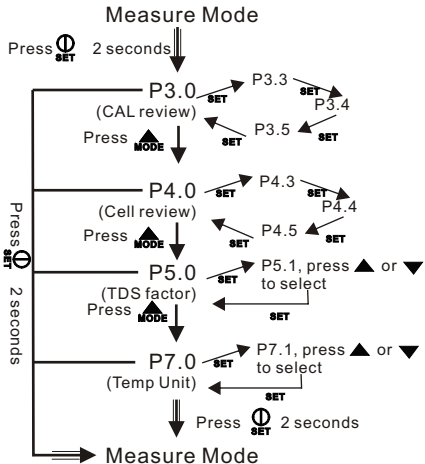

CALIBRATION MODE (CAL)

PREPARATION FOR CALIBRATION

Two issues need to be prepared and considered before operation.

First, what is the right calibration standard?

Second, when should you calibrate?

Selecting a calibration standard

DO NOT reuse the calibration solution. Contaminants in the solution will affect the calibration and the accuracy. Be sure to use fresh solution everytime.

Conductivity standard buffer is the most easy available option. So, no matter you want to calibrate TDS or Salinity or Conductivity, you can always use conductivity buffer here. For best results, select a conductivity buffer which is near the sample value you are measuring. For example, the most common buffer is 1413uS or 12.88mS or 111.8mS. If your measuring range is below 2000ppm TDS, you may use 1413uS buffer, not 12.88mS buffer. However, if your measuring range is above 2000ppm, you can use 12.88mS or other available smaller value buffer.

There are three calibration range. By using 1413uS, it is in range 1, 12.88mS is in range 2 and 111.8mS is in range 3.

Cond. Range	value
Range 1 (P3.3)	0~1999uS
Range 2 (P3.4)	2.0~19.99mS
Range 3 (P3.5)	20.0~160.0 mS

When should you do the calibration?

Calibration is necessary and should be done regularly.

-If you are measuring the mid-ranges, calibrate the meter at least once a month.

Soak the probe for 15 mins

before calibration or measurement can saturate the probe surface and minimize drift.



-If measure at the extreme temperatures or in very low/very high concentration, calibrate the meter at least once a week to get specified accuracy.

CONDUCTIVITY CALIBRATION

Please follow up below steps to proceed the conductivity calibration. It is strongly suggested to do the calibration in room temperature.

1. Insert the probe into demineralized water or distilled water for about 30 minutes to rinse the probe.
2. Select the proper conductivity standard for calibration.
3. Pour 3 cm height of the solution into two separate clean containers.
4. Power on the meter.
5. Rinse the probe into one of above containers. Gently stir the probe.
6. Dip the rinsed probe into the other container. **Please make sure there is no air bubbles attached on electrode.** Swing the probe in air can get rid of the bubble easily. Just repeat dip & swing this procedure for about 5 times.
7. Gently stir and let the probe stabilize to the solution temperature by waiting about 15 mins.

8. Press “” HOLD/CAL more than 2 seconds to begin calibration. The detected conductivity value of solution will blink on LCD. If your solution is or closed to 1413uS or 12.88mS or 111.8mS, those 3 value will be displayed as default.

9. Press “” or “” MODE and “” HOLD/CAL to change the value in order to match the displayed value to the buffer you pickup.

You can adjust the conductivity reading up to +20% from the detected value. However, if your detected value and standard value differs by more than +20%, it means cleaning or replacing meter is needed.

For example:

Standard: 5.3mS; Detected value: 3.7mS, Adjustable range: +0.7mS
_ (3.7*20%)

However, under above situation, the values already differed over 20%.

10 When the detected buffer condition is stable enough, meter will auto save calibration data in 15 seconds or you may also press “” SET to confirm the value. You will see “SA” appear on LCD to indicate the calibration is successfully done.

11. Repeat 1~9 for other ranges if needed.

To exit calibration mode without saving , you can press “” SET in step9 more than 2 seconds to quit. You won't see “SA” by doing this. This lets you retain the previous calibration data for the current range.

MAINTENANCE

- ✓ Make sure the electrode is clean! Between measurements, rinse the electrode with deionised water. If the electrode has been exposed to a solvent immiscible with water, clean it with a solvent miscible with water e.g. Ethanol and rinse carefully with water.
- ✓ Store the electrode carefully! Before storing, rinse it carefully in de-ionised water and store **dry**.

TROUBLESHOOTING

◆ Power on but no display

1. Didn't press the power key properly
2. Batteries are not installed or are not installed properly

Solution:

1. Press power key for more than 0.3 seconds to turn on the device.
2. Check whether batteries are in good contact and correct polarity. You can also remove the batteries >10 mins and then install the batteries again..

◆ Low Battery icon

1. Battery power is too low to provide accurate reading

Solution:

1. Remove all old batteries > 10 mins and then install new batteries with correct polarity and good contact. Please don't mix new and old batteries since it is easy to cause battery electrolyte leakage.

◆ Unstable reading

1. The air bubbles adhered around electrode will seriously affect the reading.

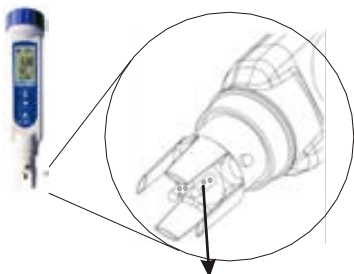

Many air bubbles adhered!



To reduce the air bubbles, dip the electrode completely and swing in air to get rid of bubble



Immerse electrode and then swing in air to get rid of air bubble. Repeat above 5 times to remove bubbles

If above method are not working, remove the electrode out of solution and blow the electrode may also remove the air bubbles from electrode

2.The sample solution is possible asymmetric to cause unstable reading

3.The probe isn't immersed deep enough in the sample solution. Please make sure both electrode and temperature sensor are immersed in solution.

4. The probe is too dirty and need maintenance

5. The probe is broken

6. The RF interference from field is too strong.

7.The low sample temperature will also cause slow response

◆ Error code

Error code E02

1. E02 means the measured value is lower than specified range

Solution:

1. Put the probe in normal tap water at room temp. for 30 mins to cancel E02 from display.
2. If above is not working, please try to do calibration

Error code E03

1. E03 means the measured value is higher than specified range

Solution:

1. Put the probe in normal tap water at room temp. for 30 mins to cancel E03 from display.
2. If above is not working, please try to do calibration

Error code E04

1. E04 means the original data error are in error

Solution:

1. Check whether the measured temp. is over range. If yes, leave the probe in normal tap water at room temp. for 30 mins to cancel E04 from display.

Error code E16

1. E16 means Cell constant of Cond probe is out of the range

Solution:

1. Re-turn on meter several times to cancel the error code from display.
2. Try to calibrate the conductivity probe to cancel E16 from display

Error code E31

1. E31 means the measuring circuit of device hardware failure.

Solution:

1. Power on/off several times to fix.

Appendix A: Conductivity to TDS Conversion Factors

Conductivity at 25°C	TDS KCl		TDS NaCl		TDS 442	
	ppm value	Factor	ppm value	Factor	ppm value	Factor
23 μ S	11.6	0.5043	10.7	0.4652	14.74	0.6409
84 μ S	40.38	0.4807	38.04	0.4529	50.5	0.6012
447 μ S	225.6	0.5047	215.5	0.4822	300	0.6712
1413 μ S	744.7	0.527	702.1	0.4969	1000	0.7078
1500 μ S	757.1	0.5047	737.1	0.4914	1050	0.7
2070 μ S	1045	0.5048	1041	0.5029	1500	0.7246
2764 μ S	1382	0.5	1414.8	0.5119	2062.7	0.7463
8974 μ S	5101	0.5685	4487	0.5	7608	0.8478
12,880 μ S	7447	0.5782	7230	0.5613	11,367	0.8825
15,000 μ S	8759	0.5839	8532	0.5688	13,455	0.897
80mS	52,168	0.6521	48,384	0.6048	79,688	0.9961

442: 40% sodium sulfate, 40% sodium bicarbonate and 20% sodium chloride.

Appendix B: Calculating TDS conversion factors

The meter can be calibrated by using TDS calibration standard solutions. The calibration standard requires the TDS value at a standard temperature such as 25 C. To determine the Conductivity-to-TDS conversion factor, please use the following formula:

$$\text{Factor} = \text{Actual TDS} : \text{Actual Conductivity @ 25}^{\circ}\text{C}$$

Definitions:

Actual TDS: Value from the solution bottle label or from a standard buffer which made by using high purity water and precisely weighed salts.

Actual Conductivity: Value measured using a properly calibrated Conductivity/TDS/Temperature meter.

Both the actual TDS and the actual conductivity values must be in the same magnitude of units. For example, if the TDS value is ppm, the conductivity value must be in uS; if the TDS value is in ppt, the conductivity value must be in mS.

Check this number by multiplying the conductivity reading by the factor in the above formula and the result is the TDS in ppm.

SPECIFICATION

Model	8352	8362	8372	8373
Cond. range	0~1999uS or 2.00~19.99mS or 20.0~160.0 mS		N/A	N/A
Cond. accuracy	+/-1%F.S +/- 1 digit		N/A	N/A
Cond. resolution	1uS or 0.01mS or 0.1mS		N/A	N/A
TDS range	N/A	0~9999ppm or 1.0~160.0 [†] ppt † is TDS factor	N/A	0~9999ppm or 1.0~160.0 [†] ppt † is TDS factor
TDS accuracy	N/A	+/-1%F.S +/- 1 digit	N/A	+/-1%F.S +/- 1 digit
TDS resolution	N/A	1ppm or 0.1ppt	N/A	1ppm or 0.1ppt
Salinity range	N/A	N/A	0~9999ppm or 1.0~100.0 ppt or 0.0%~10.0% or 0.950~1.080(S.G) based on NaCl	
Salinity accuracy	N/A	N/A	+/-1%F.S +/- 1 digit	
Salinity resolution	N/A	N/A	1ppm or 0.1 ppt or 0.1% or 0.001(S.G)	
Temp. range	-5~60.0°C			
Temp. accuracy	+/-0.5°C			
Temp. resolution	0.1			
ATC	ATC			
TDS factor		0.3~1.00	Built-in NaCl conductivity to TDS conversion factor	0.3~1.00 Built-in NaCl conductivity to TDS conversion factor
Temp. coefficient	Fixed at 2.1%/°C			
Normalization temp.	Fixed at 25°C			
LCD size	30(H)x18(W)mm			
Operating temp.	0~50°C			
Operating RH%	Humidity<80%			
Storage temp.	0~60°C			
Storage RH%	Humidity < 90%			
Sensor life time	>6 months (with good maintenance)			
Dimension	165(L)x35(W)x32(H)mm			
Weight	115g			
Battery	LR44 x 4pcs			
Standard Package	Meter/Battery/Manual/Paper box			

WARRANTY

The meter is warranted to be free from defects in material and workmanship for a period of one year from the date of purchase. This warranty covers normal operation but does not cover battery, misuse, abuse, alteration, tampering, neglect, improper maintenance, or damage resulting from leaking batteries. Proof of purchase is required for warranty repairs . Warranty is void if the meter used to be taken apart.

RETURN AUTHORIZATION

Authorization must be obtained from the supplier before returning items for any reason. When requiring a RA (Return Authorization), please include data regarding the defective reason, the meters are to be returned along with good packing to prevent any damage in shipment and insured against possible damage or loss .

Accuracy, the Zenith of Measuring / Testing Instruments !

Hygrometer/Psychrometer
Thermometer
Anemometer
Sound Level Meter
Air Flow meter
Infrared Thermometer
K type Thermometer
K.J.T. type Thermometer
K.J.T.R.S.E. type Thermometer
pH Meter
Conductivity Meter
T.D.S. Meter
D.O. Meter
Saccharimeter
Manometer
Tacho Meter
Lux / Light Meter
Moisture Meter
Data logger
Temp./RH transmitter
Wireless Transmitter

More products available !

2017/09 v01